

Panel feed-through - SACC-DSI-M12FS-12CON-M16 - 1441833

Please be informed that the data shown in this PDF Document is generated from our Online Catalog. Please find the complete data in the user's documentation. Our General Terms of Use for Downloads are valid (<http://phoenixcontact.com/download>)



Sensor/actuator flush-type connector, female connector, 12-pos. M12 SPEEDCON, A-coded, rear/screw mounting with M16 thread, with straight solder pins

Why buy this product

- Easy PCB assembly: one-piece connectors for wave soldering
- All standard pin assignments and codings for signal, data, and power transmission with a uniform design-in design
- SPEEDCON fast locking system reduces cabling times



Key Commercial Data

Packing unit	20 STK
Minimum order quantity	20 STK
GTIN	
GTIN	4046356534031

Technical data

Dimensions

Length of the solder pin	6 mm
--------------------------	------

Ambient conditions

Ambient temperature (operation)	-25 °C ... 85 °C (Plug / socket)
	-40 °C ... 85 °C (without mechanical actuation)
Degree of protection	IP67

General

Note	The electrical and mechanical data specified assume that the connector pair is correctly locked and mounted. If the connector is unlocked and if there is a danger of contamination, the connector must be sealed using a protective cap > IP54. Influences arising from litz wires, cables or PCB assembly must also be taken into consideration.
Rated current at 40°C	1.5 A
Rated voltage	30 V

Panel feed-through - SACC-DSI-M12FS-12CON-M16 - 1441833

Technical data

General

Rated surge voltage	0.8 kV
Number of positions	12
Insulation resistance	≥ 100 MΩ
Coding	A - standard
Standards/regulations	M12 connector IEC 61076-2-101
Status display	No
Overvoltage category	II
Degree of pollution	3
Connection method	Solder pins
Insertion/withdrawal cycles	> 100
Torque	3 Nm ... 4 Nm (Installation-side)
Mounting type	Rear mounting M16 x 1.5 With flat nut

Material

Flammability rating according to UL 94	V0
Contact material	CuZn
Contact surface material	Au
Contact carrier material	PA 6.6
Material, knurls	Zinc die-cast, nickel-plated
Sealing material	FKM

Cable

Standards/specifications	M12 connector IEC 61076-2-101
--------------------------	-------------------------------

Standards and Regulations

Standard designation	M12 connector
Standards/regulations	IEC 61076-2-101
Flammability rating according to UL 94	V0

Environmental Product Compliance

REACH SVHC	Lead 7439-92-1
China RoHS	Environmentally Friendly Use Period = 50
	For details about hazardous substances go to tab "Downloads", Category "Manufacturer's declaration"

Drawings

Panel feed-through - SACC-DSI-M12FS-12CON-M16 - 1441833

Dimensional drawing

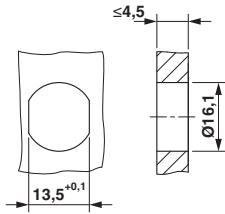

Schematic diagram

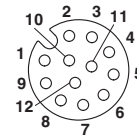

Pin assignment M12, 12-pos., female side view

Housing cutout for M16 fastening thread, mounting panel with feed-through hole (alternatively with area as anti-rotation protection for panel thicknesses > 2 mm up to max. 4.5 mm)

Dimensional drawing

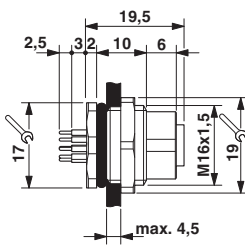

Drilling diagram

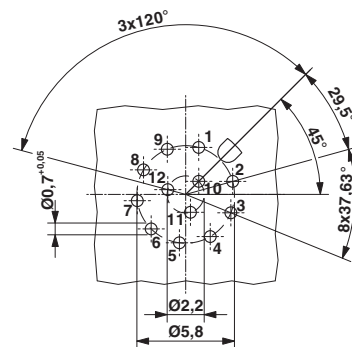

Dimensional drawing

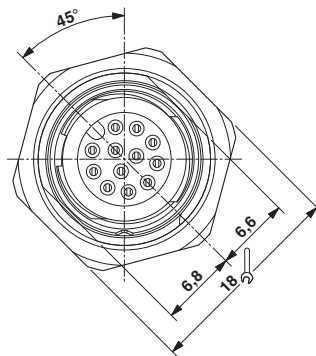

M12 front view

Approvals

Approvals

Approvals

UL Recognized / EAC / cULus Recognized

Panel feed-through - SACC-DSI-M12FS-12CON-M16 - 1441833

Approvals

Ex Approvals

Approval details

UL Recognized		http://database.ul.com/cgi-bin/XYV/template/LISEXT/1FRAME/index.htm	FILE E 118976
Nominal voltage UN		30 V	
Nominal current IN		1.5 A	
mm ² /AWG/kcmil		26	

EAC		B.01742
-----	-----------------------------------------------------------------------------------	---------

cULus Recognized		http://database.ul.com/cgi-bin/XYV/template/LISEXT/1FRAME/index.htm	E221474-20140616
Nominal voltage UN		30 V	
Nominal current IN		1.5 A	
mm ² /AWG/kcmil		26	

Phoenix Contact 2018 © - all rights reserved
<http://www.phoenixcontact.com>

PHOENIX CONTACT GmbH & Co. KG
Flachmarktstr. 8
32825 Blomberg
Germany
Tel. +49 5235 300
Fax +49 5235 3 41200
<http://www.phoenixcontact.com>